

AYTON

DEBONADEMEO DESIGN / 2019



BORZALINO
INTERIORS • 1976 • TUSCANY

AYTON

Passato e presente, tradizione e innovazione si incontrano nel sistema di divani Ayton. Design ispirato alle geometrie nordiche degli anni 50 dal gusto contemporaneo. La struttura si solleva da terra in un piano orizzontale a conchiglia che racchiude un cuore soffice e accogliente. Ayton si compone di varie tipologie di sedute e ripiani combinabili all'infinito per adattarsi con naturalezza agli ambienti domestici e pubblici.

Struttura: in tubolare metallico curvato. **Sospensione seduta:** telaio in multistrato di pioppo sagomato e forato per permettere la fuori uscita dell'aria dal cuscino in piuma. **Supporto schienale:** in tubolare metallico con cinghie elastiche ammortizzanti. **Imbottiture:** Schienale fisso in poliuretano espanso di densità 25Kg/m³ e rivestito con trapuntino in piuma canalizzata per garantire una localizzazione della piuma netta e costante nel tempo. Il trapuntino in piuma conferisce morbidezza e sofficià. Sedute fisse in poliuretano espanso a quote differenziate di densità 35/30/25Kg/m³ rivestito con trapuntino in piuma canalizzata che conferisce sofficià al cuscino. **Dettaglio:** doppia tiratura enfatizzata da ricamo compatto a zig-zag. **Piedini:** in metallo laccato o trattato galvanicamente con appropriati sottopiedi in plastica.

EN Past and present, tradition and innovation combine in Ayton sofa system. Design inspired by Nordic geometries of the '50s with contemporary taste. The structure rises from the ground in a horizontal plane as if in a shell that encloses a soft and welcoming heart. Ayton is a fully modular composition of seats and shelves that naturally adapts to every space, from domestic to public.

Structure: in curved metal tube. **Seat springing:** frame in poplar plywood shaped and perforated to allow the exit of air from the feather pillow. **Backrest support:** in metal tube with elastic straps. **Fillings:** fixed backrest in density 25 Kg/m³ polyurethane foam and covered with feather quilt channelled in order to guarantee that the feathers remain neatly and constantly in place over time. The feather quilt gives roundness and softness. Fixed seat cushions in polyurethane foam density 35/30/25Kg/m³ covered with feather quilt channelled that gives softness to the cushion. **Detail:** double stitching emphasized by compact zig zag embroidery. **Feet:** in lacquered metal or galvanized with appropriate plastic glides.

FR Passé et présent, tradition et innovation se rencontrent dans le système de canapé Ayton. Design inspiré par les géométries nordiques des années 50 avec un style contemporain. La structure se détache du sol dans un plan horizontal en forme de coquille qui encadre un cœur doux et accueillant. Ayton est composé de différents types de sièges qui peuvent être combinés à l'infini pour s'adapter naturellement aux environnements domestiques et publics.

Structure: en tube métallique incurvé. **Suspension d'assise:** châssis en multiplis de peuplier profilé et perforé pour permettre la sortie de l'air du coussin en plumes. **Support de dossier:** en tube métallique avec sangles élastiques. **Rembourrage:** dossier fixe en mousse polyuréthane densité 25 Kg/m³ couverts par un couette en duvet à secteurs pour garantir au duvet une localisation nette et constante dans le temps. La couette en duvet donne douceur et souplesse. Coussins d'assise fixes en mousse polyuréthane densité 35/30/25 Kg/m³ couvert par un couette en duvet à secteurs qu'il confère souplesse au coussin. **Détail:** Double étirage soulignée par une broderie zigzag compacte. **Pieds:** en métal laqué ou galvanisé avec des patins en plastique appropriés.

SCelta FINITURE
CHOICE OF FINISHES
CHOIX DE FINITIONS



PELLE
LEATHER
CUIR

[Consulta le pelli](#)
[Discover the leathers](#)
[Consultez les cuirs](#)



FILO
THREAD
FIL

[Consulta i fili](#)
[Discover the threads](#)
[Consultez les fils](#)



TESSUTO
FABRIC
TISSU

[Consulta i tessuti](#)
[Discover the fabrics](#)
[Consultez les tissus](#)



PIETRA
STONE
PIERRE

[Consulta le pietre](#)
[Discover the stones](#)
[Consultez les pierres](#)



METALLO
METAL
MÉTAL

[Consulta i metalli](#)
[Discover the metals](#)
[Consultez les métaux](#)



RICAMO
EMBROIDERY
BRODERIE

[Consulta i ricami](#)
[Discover the embroideries](#)
[Consultez les broderies](#)



LEGNO
WOOD
BOIS

[Consulta i legni](#)
[Discover the woods](#)
[Consultez les bois](#)

BORZALINO

INTERIORS • 1976 • TUSCANY



sofa 310x90 h 82 - 3 seats 98 / Leather art. TUSCANIA col. 27. Metal feet finish col. Gloss Black.



sectional sofa 347/190x90 h 82 / Element 85 arm LHF seat 78 + Corner 90° + Element 242 arm RHF 3 seats 78
Frame Leather art. SETA col. 32815 / Seat and back cushions fabric art. BUNNIE Z560 col. 02
Arm cushions Fabric art. BUNNIE Z560 col. 02. Metal feet finish col. Vulcan Grey.

DETAILS



ricamo compatto a zig-zag
compact zig zag embroidery
broderie zigzag compacte



piedini in metallo
metal feet
pieds en métal



con tavolo integrato
with built-in-table
avec table intégrée

AYTON



armchair 95x90 h 82

Frame leather art. RUSTICO col. 11. Seat and back fabric art. EGO L1347 col. 02. Metal feet finish col. Vulcan Grey
 Frame leather art. GHOST col. 33. Seat, back and arm cushion art. EDEN col. 002. Metal base finish col. Vulcan Grey

95x90 h 82

EUAYPOLT /poltrona
/armchair
/fauteuil

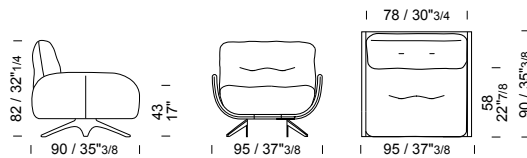

ALL 6 mt 10 m² 0,80 m³ 51 kg

95x90 h 82

EUAYPOLG /poltrona girevole
/swivel armchair
/fauteuil pivotant

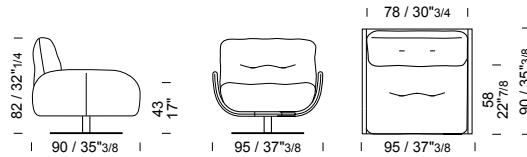

ALL 6 mt 10 m² 0,80 m³ 51 kg

172x90 h 82

EUAYD02P /divano
/sofa
/canapé

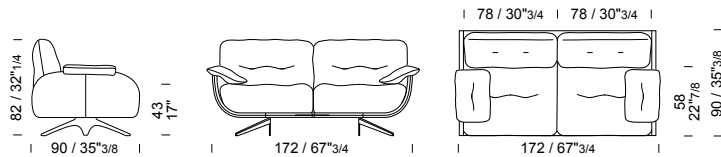

ALL 8 mt 13 m² 1,4 m³ 90 kg

212x90 h 82

EUAYDINT /divano
/sofa
/canapé

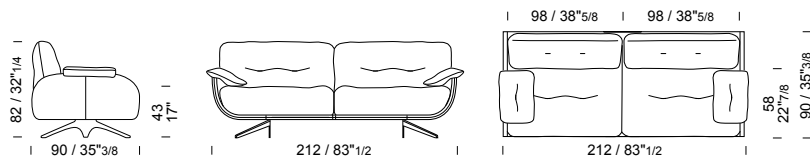

ALL 9 mt 14 m² 1,73 m³ 95 kg

AYTON



sofa 250x90 h 82 - 3 seats 78 / Frame Leather art. GHOST col. 33.
Seat, back and arm cushions leather art. VANILLA col.9. Metal feet finish col. Vulcan Grey

250x90 h 82

EUAyD03P /divano
/sofa
/canapé

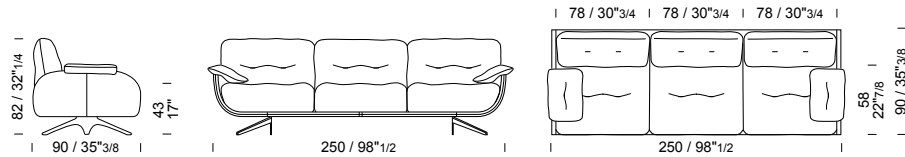

ALL 11,5 mt 18 m² 2,06 m³ 99 kg

310x90 h 82

EUAyD04P /divano
/sofa
/canapé

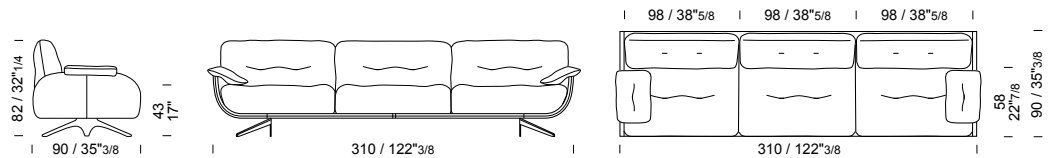

ALL 13 mt 20 m² 2,54 m³ 107 kg

212x90 h 82

EUAyDT27 /divano con tavolo integrato
/sofa with built-in-table
/canapé avec table intégrée

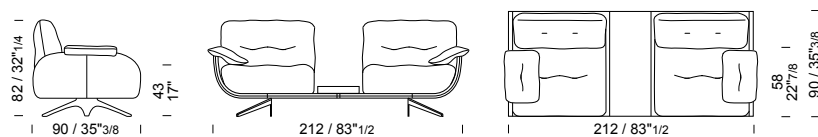

ALL 8 mt 14 m² 1,73 m³ 95 kg

AYTON



sofa with built-in table 250x90 h 82 - 2 seats 98 / Frame leather art. VESUVIO col. 720049.
 Seat and back cushions leather art. SETA col. 681373.
 Arm cushions leather art. SETA col. 681373. Metal feet finish col. Titanio. Table Canaletto walnut wood

250x90 h 82

EUAyDT29 /divano con tavolo integrato
 /sofa with built-in-table
 /canapé avec table intégrée

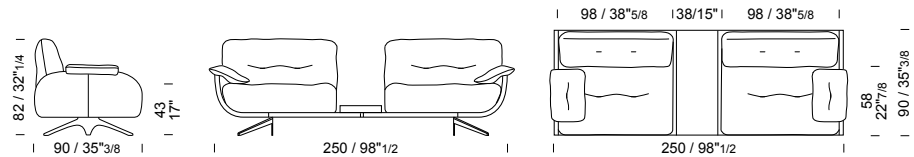

ALL 9 mt 15 m² 2,06 m³ 99 kg

85x90 h 82

EUAyES17 /laterale SX
 /element LHF
 /batard GVF

EUAyED17 /laterale DX
 /element RHF
 /batard DVF

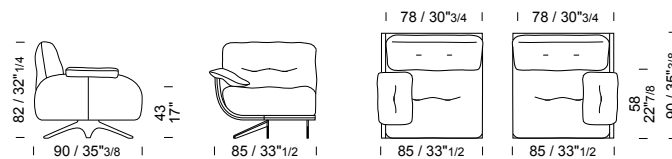

ALL 4,5 mt 9 m² 0,73 m³ 48 kg

105x90 h 82

EUAyES19 /laterale SX
 /element LHF
 /batard GVF

EUAyED19 /laterale DX
 /element RHF
 /batard DVF

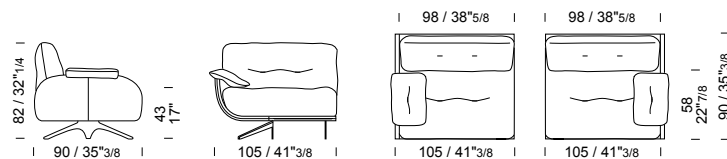

ALL 5 mt 9,5 m² 1,05 m³ 58 kg

AYTON



sectional sofa 316/216x90 h 82 / Element 204 arm LHF 2 seats 98 + Corner + Element 105 arm RHF 1 seat 98
 Frame leather art. VESUVIO col. 370050. Seat and back cushions Velvet art. FILIGRANA col. 05.
 Arm cushions Leather art. VESUVIO col. 370050. Metal feet finish col. Vulcan Grey

164x90 h 82

EUAYES27 /laterale SX
 /element LHF
 /batard GVF

EUAYED27 /laterale DX
 /element RHF
 /batard DVF

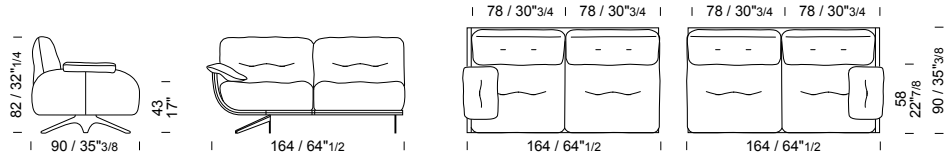

ALL 7 mt 12 m² 1,35 m³ 86 kg

204x90 h 82

EUAYES29 /laterale SX
 /element LHF
 /batard GVF

EUAYED29 /laterale DX
 /element RHF
 /batard DVF

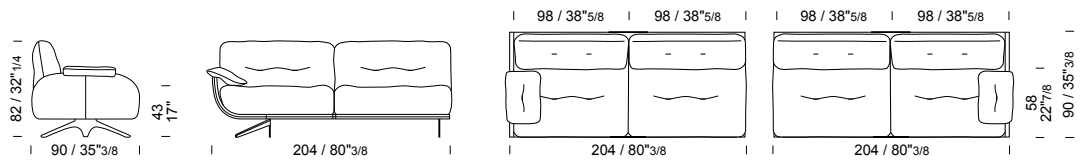

ALL 8 mt 13 m² 1,86 m³ 90,5 kg

242x90 h 82

EUAYES37 /laterale SX
 /element LHF
 /batard GVF

EUAYED37 /laterale DX
 /element RHF
 /batard DVF

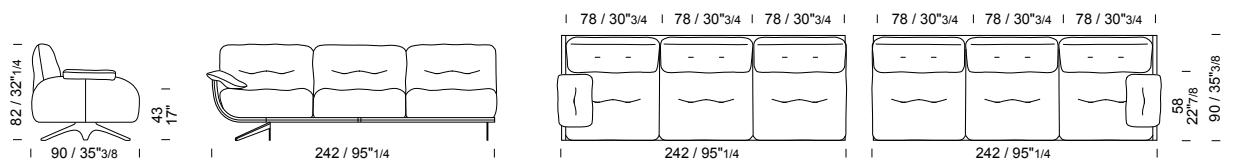

ALL 10 mt 15 m² 1,98 m³ 95 kg

302x90 h 82

EUAYES39 /laterale SX
/element LHF
/batard GVF

EUAYED39 /laterale DX
/element RHF
/batard DVF

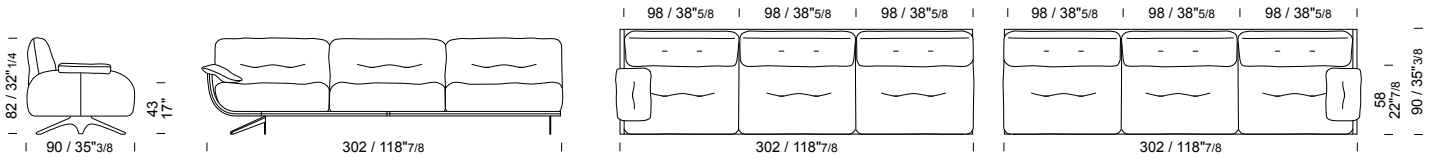

ALL 11 mt 18 m² 2,45 m³ 105 kg

105x105 h 82

EUAYANGO /angolo 90°
/corner 90°
/angle 90°

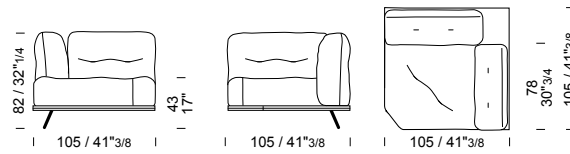

ALL 5,5 mt 8,5 m² 1,03 m³ 61 kg



bench 172x60 h 56 - 2 seats 78 / Frame Leather art. GHOST col. 33.
Seat cushions Leather art. TUSCANIA col. 22. Metal feet finish col. Titanio.

172x60 h 56

EUAYPA27 /panchetta
/bench
/banc

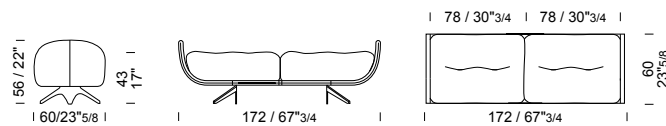

ALL 3,5 mt 6,5 m² 0,63 m³ 43 kg

212x60 h 56

EUAyPA29 /panchetta
/bench
/banc

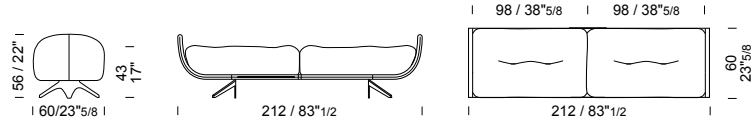

ALL 3,5 mt 6,5 m² 0,75 m³ 50 kg

85x60 h 43

EUAyPF78 /pouf
/pouf
/pouf



ALL 2 mt 3,5 m² 0,28 m³ 22 kg



pouf 105x60 h 43 / Frame Leather art. GHOST col. 31.
Seat cushion fabric art. KUBOA 9072 col. 02. Metal feet finish col. Titanio.

105x60 h 43

EUAyPF98 /pouf
/pouf
/pouf

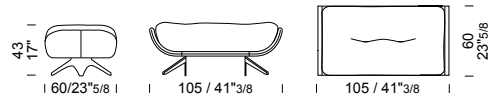

ALL 2 mt 3,5 m² 0,36 m³ 25 kg

45x30

EUAyCB /cuscino decorativo
/pillow
/coussin déco

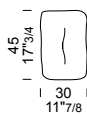

ALL 0,6 mt 0,7 m²

Composition A

EUAYES29
EUAYANGO
EUAYED19

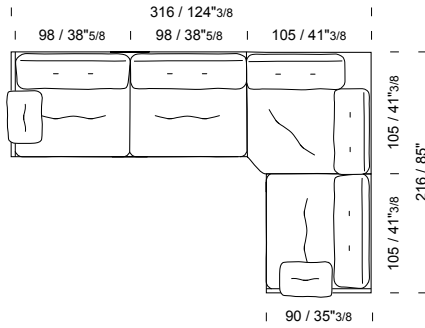

Composition B

EUAYES39
EUAYANGO
EUAYED19

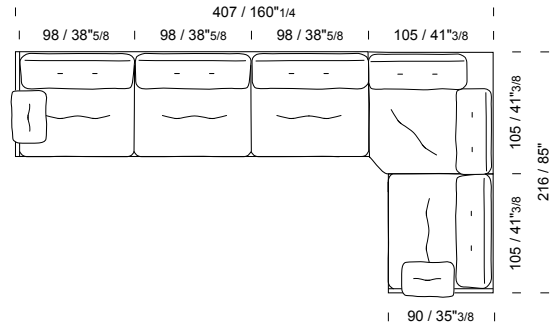

Composition C

EUAYES17
EUAYANGO
EUAYED37

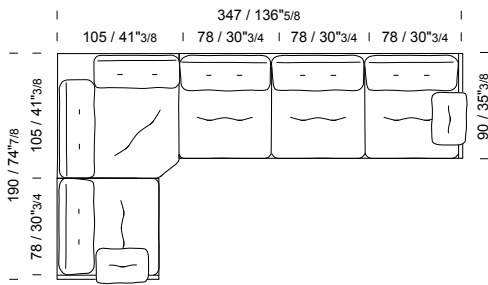

Composition D

EUAYES17
EUAYANGO
EUAYED27

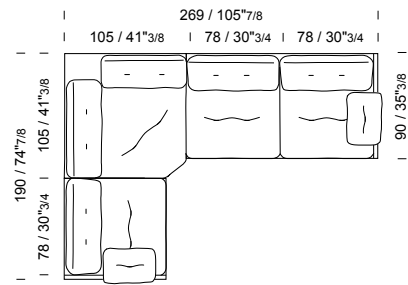

sectional sofa 347/190x90 h 82 / Element 85 arm LHF seat 78 + Corner 90° + Element 242 arm RHF 3 seats 78
Frame Leather art. SETA col. 32815 / Seat and back cushions fabric art. BUNNIE Z560 col. 02
Arm cushions Fabric art. BUNNIE Z560 col. 02. Metal feet finish col. Vulcan Grey.



