

NEW KAP

BORZALINO DESIGN /2018



BORZALINO
INTERIORS • 1976 • TUSCANY

NEW KAP

Anello di congiunzione tra la tradizionalità di una lavorazione artigianale come il capitonné, fatto a mano da pelli intiere, e le linee pulite che contraddistinguono lo stile contemporaneo con risultati eccezionali sia sul piano estetico che ergonomico.

Struttura: in multistrati di pioppo e legno massello. **Sospensione seduta:** cinghie elastiche incrociate. **Imbottiture:** scocca schienale fisso in poliuretano espanso a quote differenziate di densità 30/25Kg/m³. Seduta estraibile in poliuretano espanso di densità 35Kg/m³ e bombatura in Visco elastico densità 95Kg/m³ rivestiti in tomana gr. 100. **Dettaglio:** l'imbottitura dello schienale viene lavorata completamente a mano, una lavorazione che richiede grande abilità manuale nonché un lavoro molto minuzioso e accurato. Si creano una serie di rombi grandi al centro dello schienale e man mano che si avvicina al bracciolo la dimensione dei rombi si riduce e poi vengono applicati dei bottoni dello stesso rivestimento.

Piedini: in metallo laccato o trattato galvanicamente con appropriati sottopiedi in plastica. Si consiglia di arricchire la composizione con i cuscini arredo opzionali suggeriti nelle immagini.

Tolleranza +/- 5cm delle dimensioni totali del prodotto.

EN A conjunction ring between the traditionality of a craftsmanship like the capitonné, handmade from whole leather, and the clean lines that distinguish the contemporary style. The result is exceptional, both in aesthetics and ergonomicity.

Structure: poplar plywood and solid wood. **Seat springing:** criss-crossed elastic straps. **Fillings:** fixed frame and backrest in differentiated density 30/25Kg/m³. Removable seat cushions in 35 Kg/m³ density polyurethane foam and camber in Memory foam density 95kg/m³ covered with synthetic lining 100gr. **Detail:** the padding of the backrest is processed completely by hand, a process that requires great manual skill as well as a very meticulous and accurate work. A series of large rhombuses are created in the middle of the backrest and gradually approaching at the armrest the size of the rhombuses is reduced and then buttons of the same coating are applied. **Feet:** in lacquered metal or galvanized with appropriate plastic glides.

It is advisable to embellish the sofa with the optional decorative pillows recommended in the images.

Tolerance +/- 5cm of total product dimensions.

FR Un lien entre le savoir-faire artisanal traditionnel de fabrication comme le capitonné, fait à la main à partir de peaux entières, et les lignes épurées qui caractérisent le style contemporain avec des résultats exceptionnels sur le plan esthétique et ergonomique.

Structure: carcasse en multiplis de peuplier et en bois massif. **Suspension d'assise:** sangles élastiques entrecroisées. **Rembourrage:** dossier fixe en mousse polyuréthane densité 30/25 Kg/m³ garni avec de fibre polyester. Coussins d'assise amovibles en mousse polyuréthane densité 35 Kg/m³ avec bombé en mousse mémoire garni avec housse en fiber 100gr. **Détail:** le rembourrage du dossier est entièrement réalisé à la main, un processus qui nécessite une grande habileté manuelle ainsi qu'un travail méticuleux et précis. Une série de grands losanges sont créés au milieu du dossier et progressivement à l'accoudoir la taille des losanges est réduite et ensuite des boutons du même revêtement sont appliqués. **Pieds:** en métal laqué ou galvanisé avec des patins en plastique appropriés.

Il est conseillé d'orner le canapé avec les coussins décoratifs optionnels proposés dans les images.

Tolérance +/- 5 cm des dimensions totales du produit.

SCELTA FINITURE
CHOICE OF FINISHES
CHOIX DE FINITIONS



PELLE
LEATHER
CUIR

[Consulta le pelli](#)
[Discover the leathers](#)
[Consultez les cuirs](#)



FILO
THREAD
FIL

[Consulta i fili](#)
[Discover the threads](#)
[Consultez les fils](#)



TESSUTO
FABRIC
TISSU

[Consulta i tessuti](#)
[Discover the fabrics](#)
[Consultez les tissus](#)



GROS-GRAIN
GROS-GRAIN
GROS-GRAIN

[Consulta i gros-grain](#)
[Discover the gros-grain](#)
[Consultez les gros-grain](#)



METALLO
METAL
MÉTAL

[Consulta i metalli](#)
[Discover the metals](#)
[Consultez les métaux](#)

BORZALINO

INTERIORS • 1976 • TUSCANY



sofa 210x94 h 76 / Leather art. RUSTICO col. 18. Seat trimming Gros grain col. 4548. Metal feet finish col. SW268JR Bronze.



sofa corner 360/195x94 h 76 / Element 210 LHF + Corner 60° + Element 105 RHF
Leather art. TUSCANIA col. 22 - Seat trimming Gros grain col. 4503 . Metal feet finish col. Titanio.
pillow 55x45 / Velvet art. BOSS col. 6092 - Fabric art. CINERA 9054 col. 03 - pillow 60x60 / Fabric art. CINERA 9054 col. 03

DETAILS



lavorazione Capitonné fatta a mano
handmade Capitonné processing
travail de Capitonné fait à la main



Il motivo Capitonné si ridimensiona
seguendo la linea del bracciolo
The Capitonné pattern is resized following
the armrest line
Le motif Capitonné est redimensionné en
suivant la ligne d'accoudoir



piedini in metallo
 metal feet
 pieds en métal

NEW KAP



armchair 90x94 h 76 / Outside-frame leather art. SETA col. 61523. Inside-frame and seat fabric art. BOSS col. 7080. Seat trimming Gros grain col. 4519. Metal feet finish col. SW268JR Bronze.

90x94 h 76

EUNPPOLT /poltrona
/armchair
/fauteuil

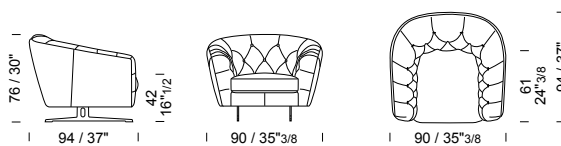

ALL 6 mt 10 m² 0,80 m³ 60,0 kg



sofa 230x94 h 76 / Outside frame leather art. SETA col. 80667. Inside frame + seat cushion leather EPIC col. 1311. Seat cushion trimming leather art. Seta col. 80667. Metal feet finish col. Burnished Bronze.

170x94 h 76

EUNPD02P /divano
/sofa
/canapé

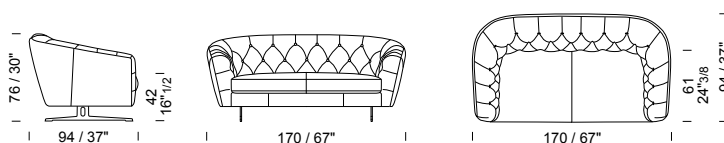

ALL 6,5 mt 12,5 m² 1,44 m³ 72,5 kg

NEW KAP



sofa 210x94 h 76 / Outside-frame leather art. SETA col. 61523. Inside-frame and seat fabric art. BOSS col. 7080. Seat trimming Gros grain col. 4519. Metal feet finish col. SW268JR Bronze.

190x94 h 76

EUNPDINT /divano
/sofa
/canapé

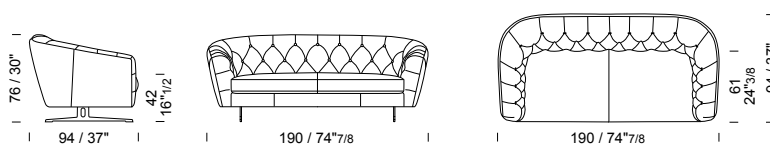

ALL 7,5 mt 13,5 m² 1,6 m³ 73,5 kg

210x94 h 76

EUNPD03P /divano
/sofa
/canapé

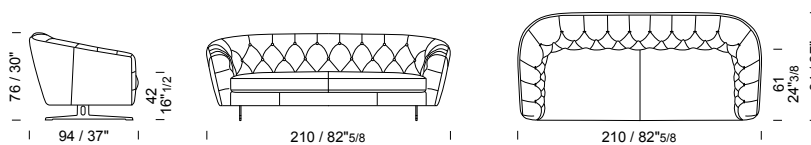

ALL 8,5 mt 14,5 m² 1,72 m³ 74,5 kg

230x94 h 76

EUNPD04P /divano
/sofa
/canapé

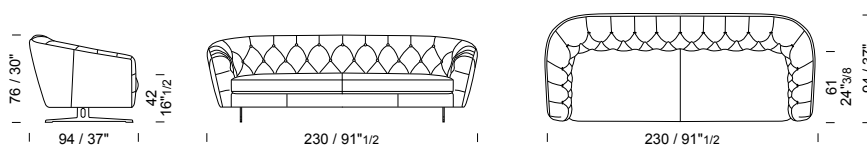

ALL 9 mt 15,5 m² 1,88 m³ 75,5 kg

NEW KAP



Vis à Vis 210x110 h 76 / Outside-frame Leather art. NABUK col. 96 - Inside-frame and seat fabric art. SORBARA col. 7
Seat trimming Gros grain col. 4519 - Metal feet finish col. Titanio.

210x110 h 76

EUNPVISA /divano Vis à Vis
/ Vis à Vis sofa
/canapé Vis à Vis

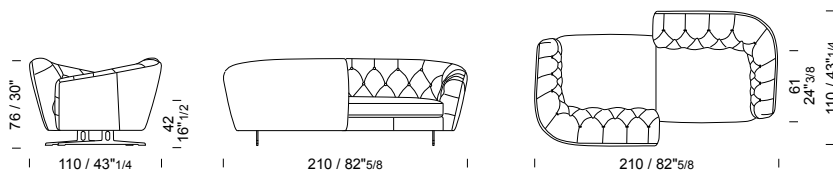

ALL 7,5 mt 12 m² 2,01 m³ 74,9 kg



sofa corner 360/195x94 h 76 / Element 210 LHF + Corner 60° + Element 105 RHF
Outside-frame leather RUSTICO col. 10. Inside-frame and seat cushion fabric art. VALANTE 9050 col. 02. Seat trimming Gros-grain col. 4503.
Metal feet finish col. Titanio. **pillow 60x60** / Fabric art. CINERA 9054 col. 03 **pillow 55x45** / Velvet art. BOSS col. 6059.

105x94 h 76

EUNPLS5 /laterale SX
/element LHF
/batard GVF

EUNPLD5 /laterale DX
/element RHF
/batard DVF

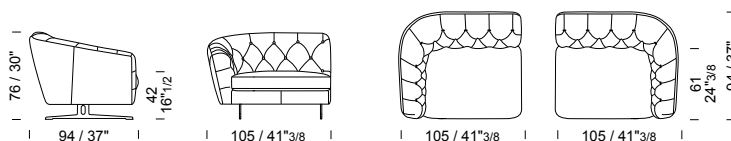

ALL 5 mt 7,5 m² 0,8 m³ 49 kg

NEW KAP

150x94 h 76

EUNPLS50 /laterale SX
/element LHF
/batard GVF

EUNPLD50 /laterale DX
/element RHF
/batard DVF

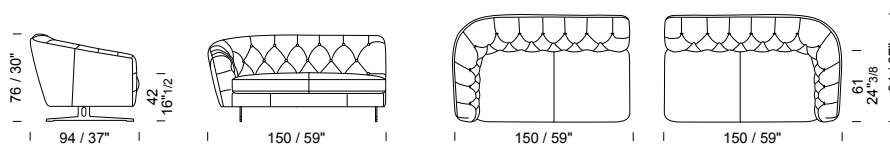

ALL 6 mt 12 m² 1,28 m³ 67,5 kg

170x94 h 76

EUNPLS17 /laterale SX
/element LHF
/batard GVF

EUNPLD17 /laterale DX
/element RHF
/batard DVF

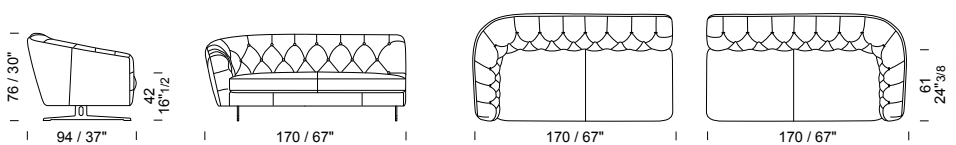

ALL 6,5 mt 12,5 m² 1,44 m³ 69,5 kg

190x94 h 76

EUNPLS19 /laterale SX
/element LHF
/batard GVF

EUNPLD19 /laterale DX
/element RHF
/batard DVF

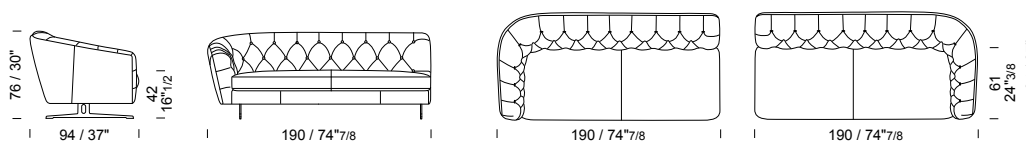

ALL 7 mt 13 m² 1,60 m³ 71,5 kg

210x94 h 76

EUNPLS21 /laterale SX
/element LHF
/batard GVF

EUNPLD21 /laterale DX
/element RHF
/batard DVF

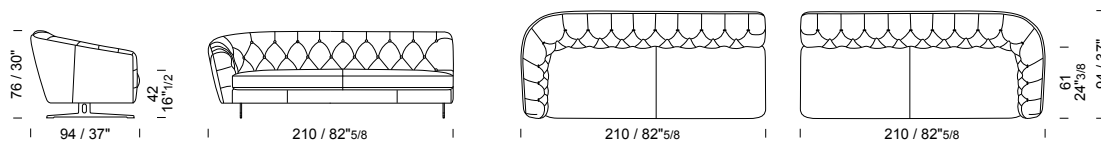

ALL 7,5 mt 13,5 m² 1,72 m³ 73,5 kg

NEW KAP

130x94 h 76

EUNPC130 /centrale
/seat
/chauffeuse

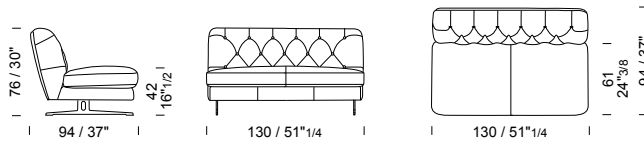

ALL 5,5 mt 9 m² 1,12 m³ 52 kg

150x94 h 76

EUNPC150 /centrale
/seat
/chauffeuse

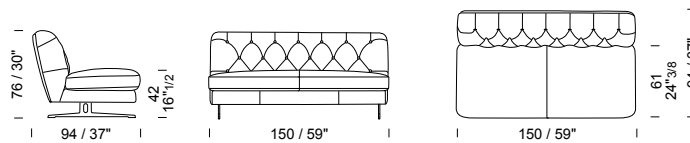

ALL 6 mt 10 m² 1,28 m³ 53 kg

170x94 h 76

EUNPC170 /centrale
/seat
/chauffeuse

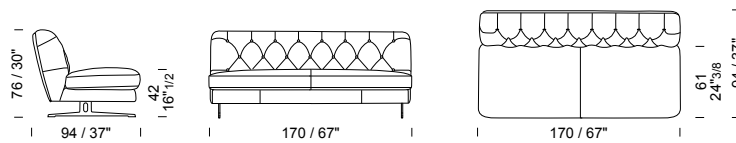

ALL 6 mt 11 m² 1,44 m³ 54 kg

190x94 h 76

EUNPC190 /centrale
/seat
/chauffeuse

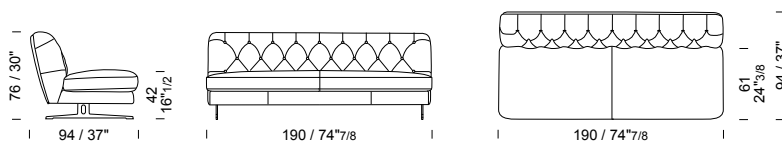

ALL 6,5 mt 12 m² 1,6 m³ 55 kg

NEW KAP



sofa corner 360/195x94 h 76
 / Element 210 LHF + Corner 60° + Element 105 RHF
 Outside-frame leather RUSTICO col. 10.
 Inside-frame and seat cushion fabric art. VALANTE 9050 col. 02.
 Seat trimming Gros-grain col. 4503. Metal feet finish col. Titanio.

110x110 h 76

EUNPANG6 /angolo 60°
 /corner 60°
 /angle 60°

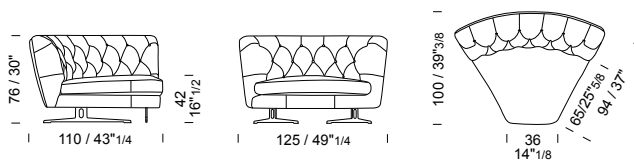

ALL 4 mt 6,5 m² 1,12 m³ 49 kg

120x120 h 76

EUNPANGO /angolo 90°
 /corner 90°
 /angle 90°

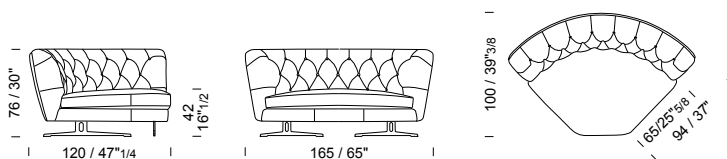

ALL 5 mt 8 m² 1,12 m³ 55 kg

105x165 h 76

EUNPPENS /penisola SX
 /chaise longue LHF
 /meridienne GVF

EUNPPEND /penisola DX
 /chaise longue RHF
 /meridienne DVF

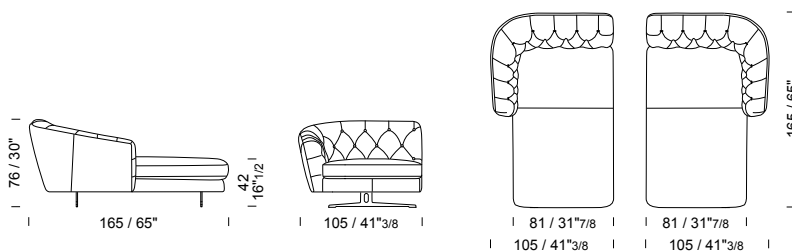

ALL 6 mt 11 m² 2,01 m³ 74 kg

NEW KAP



pouf Ø 80 h 40 / Fabric art. SORBARA col. 7

Ø 80 h 40

EUNPP0D8 /pouf
/pouf
/pouf

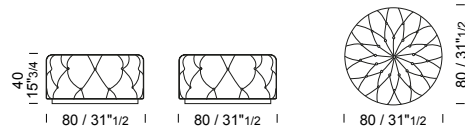

ALL 2,5 mt 4 m² 0,45 m³ 16,5 kg

70x70 h 40

EUNPP070 /pouf
/pouf
/pouf

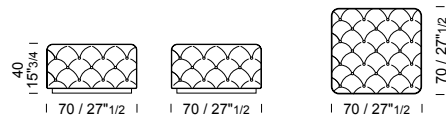

ALL 2 mt 3,5 m² 0,45 m³ 16,5 kg

55x45

EUNPC554 /cuscino decorativo
/pillow
/coussin déco

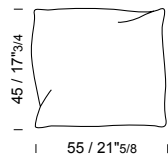

ALL 0,8 mt 1 m²

60x60

EUNPC66 /cuscino decorativo
/pillow
/coussin déco

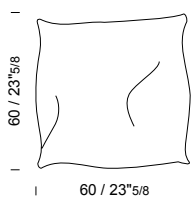

ALL 0,8 mt 1 m²

Composition A

EUNPLS21
EUNPANG6
EUNPLD5

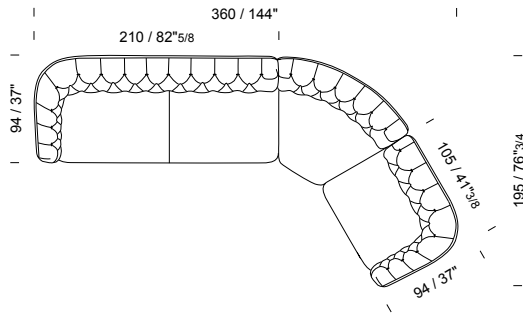

Composition B

EUNPLS21
EUNPPEND

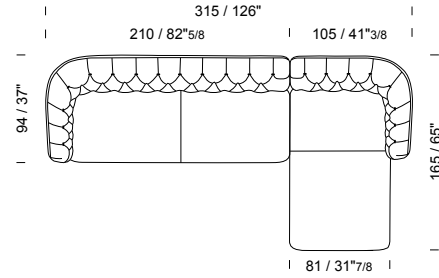

Composition C

EUNPLD21
EUNPANGO
EUNPLS5

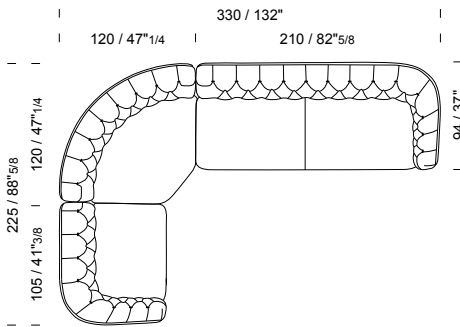

Composition D

EUNPLS17
EUNPLD17

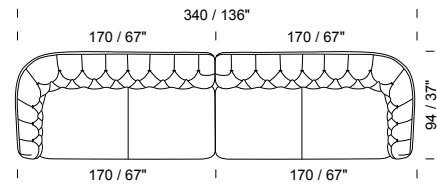

Composition E

EUNPC190
EUNPANGO (2)
EUNPLS21
EUNPLD21

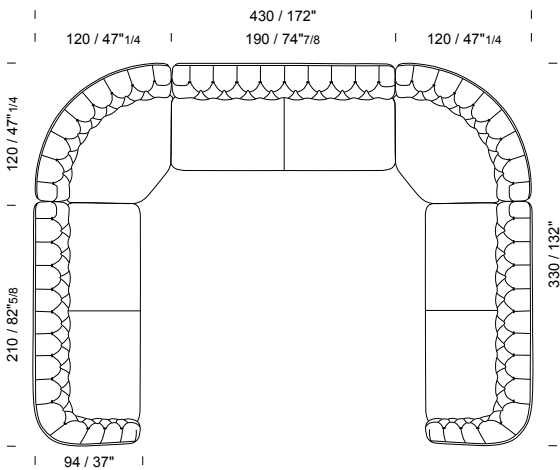

Composition F

EUNPC190
EUNPANG6 (2)
EUNPLS5
EUNPLD5

